

Commercial Downlights



CDL4-6W-13W-VAR-WH-V1
 CDL6-10W-24W-VAR-WH-V1
 CDL8-16W-30W-VAR-WH-V1

Date:	Project:
Prepared for:	Type:
Comments:	



Our high-brightness commercial downlights feature 5 selectable wattages and 5 CCT options, delivering flexible, efficient lighting. With up to 3350 lumens, 90+ CRI, ≥ 114 lm/W max efficacy, and smooth 0–10V on 120–347V, they provide reliable, high-quality illumination for residential and commercial applications.

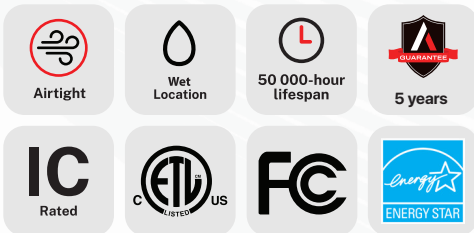

Specifications

Input Voltage	120–347Vac
Power	5.5W / 7W / 9W / 10W / 13W 9.5W / 13W / 18.5W / 21W / 24W 16W / 20W / 23W / 27W / 30W
Input current	53 / 61 / 80 / 93 / 107mA 86 / 115 / 163 / 182 / 198mA 136 / 169 / 192 / 230 / 247mA
Beam Angle	95°
CCT	2700K / 3000K / 3500K / 4000K / 5000K
CRI	90+
Dimming Type	0–10V / ELV
UGR	<22
THD	<25%

Efficacy	≥ 114 lm/W max
Lumen Output	1450 lm 2750 lm 3350 lm
Weight	0.80 lb (363 g) 1.33 lb (603 g) 1.66 lb (753 g)
Length of Leads	26" (660mm)
Wire Gauge	18AWG
Finish	White
Material	Polycarbonate; Aluminum; Steel
Operating temperature	-25°C to 40°C
IP Rating	IP54 (Front)
Environment	Wet location

Commercial Downlights



CDL4-6W-13W-VAR-WH-V1
 CDL6-10W-24W-VAR-WH-V1
 CDL8-16W-30W-VAR-WH-V1

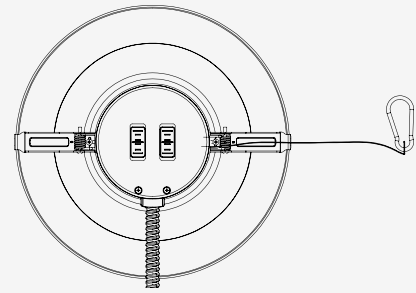
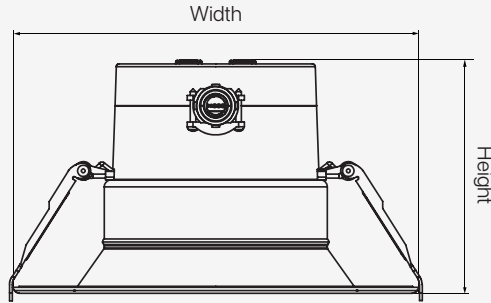

Dimensions

CDL4-6W-13W-VAR-WH-V1	CDL6-10W-24W-VAR-WH-V1	CDL8-16W-30W-VAR-WH-V1
W Ø 6" (151.9 mm) x H 3-5/8" (91.7 mm)	W Ø 8-7/16" (214 mm) x H 4-1/16" (104 mm)	W 10-1/16" (255 mm) x H 4-7/16" (112 mm)
Minimum Cutout : 4-15/16" (125 mm)	Minimum Cutout : 6-1/8" (155 mm)	Minimum Cutout : 7-5/16" (186 mm)

Order information

Ordering Code	Power (Selectable)	Lumens	Model Number	Colour Temperature
CDL4-6W-13W-VAR-WH-V1	5.5W/7W/9W/10W/13W	1450lm @13W	CDL04R0013W-DDKMVDWHS-V1	27K/30K/35K/40K/50K
CDL6-10W-24W-VAR-WH-V1	9.5W/13W/18.5W/21W/24W	2750lm @ 24W	CDL06R0024W-DDKMVDWHS-V1	27K/30K/35K/40K/50K
CDL8-16W-30W-VAR-WH-V1	16W/20W/23W/27W/30W	3350lm @ 30W	CDL08R0030W-DDKMVDWHS-V1	27K/30K/35K/40K/50K

Photometrics

CDL4-6W-13W-VAR-WH-V1

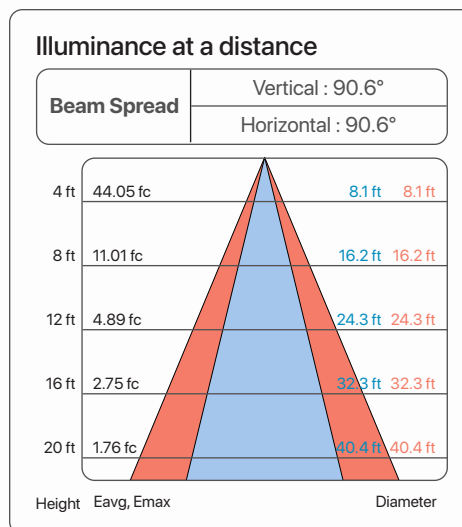
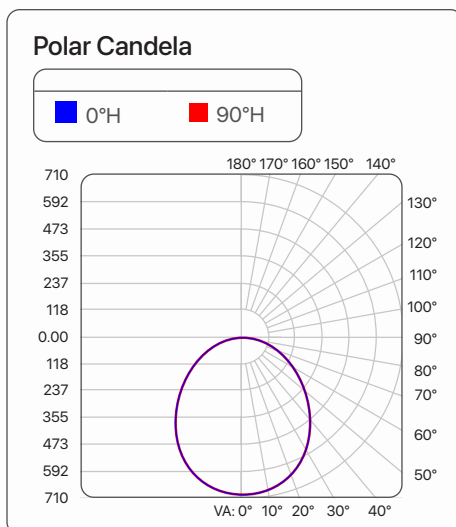

Zonal Lumen Summary

Zone	Lumens	% Luminaire
0-30	524.0	35.4%
0-40	824.9	55.7%
0-60	1,306.7	88.2%
60-90	175.3	11.8%
0-90	1,482.0	100%

Commercial Downlights



CDL4-6W-13W-VAR-WH-V1
 CDL6-10W-24W-VAR-WH-V1
 CDL8-16W-30W-VAR-WH-V1

Photometrics

CDL6-10W-24W-VAR-WH-V1

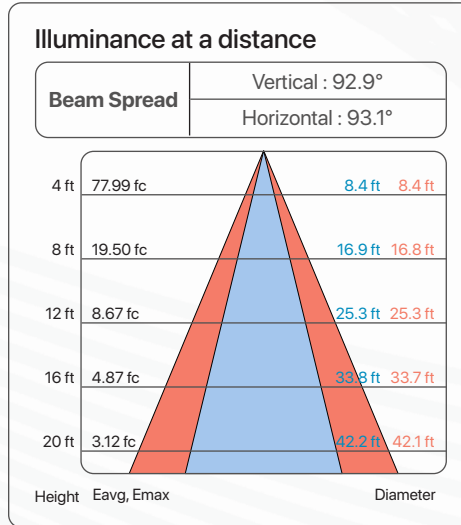
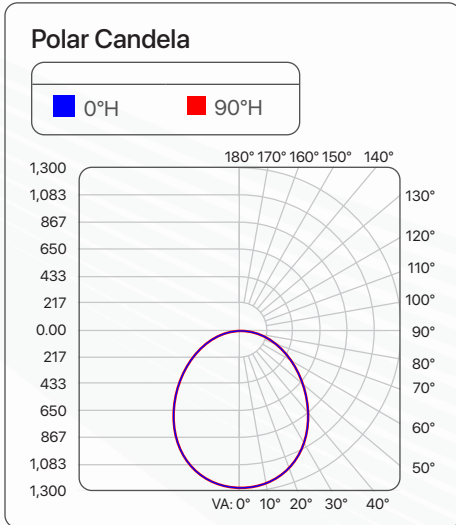

Zonal Lumen Summary

Zone	Lumens	% Luminaire
0-30	940.2	35.4%
0-40	1,495.0	56.2%
0-60	2,378.1	89.4%
60-90	280.6	10.6%
0-90	2,658.7	100%

CDL8-16W-30W-VAR-WH-V1

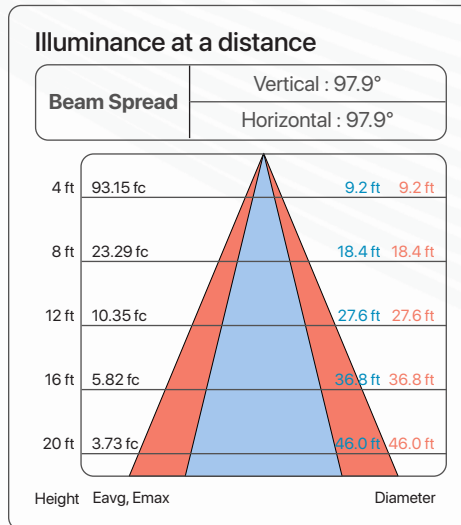
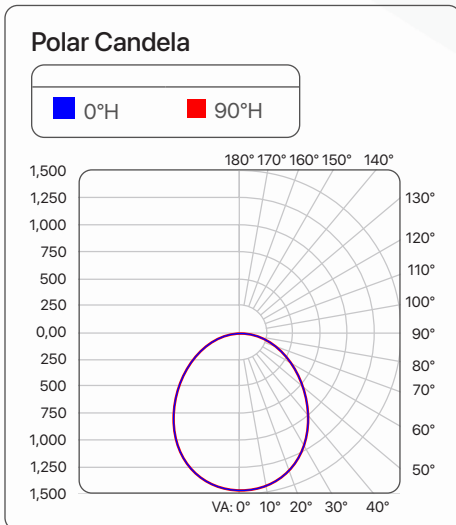

Zonal Lumen Summary

Zone	Lumens	% Luminaire
0-30	1126.9	33.8 %
0-40	1805.2	54.2 %
0-60	2966.9	89.1 %
60-90	364.6	10.9 %
0-90	3331.5	100 %