

| | |
|---------------|----------|
| Date: | Project: |
| Prepared for: | Type: |
| Comments: | |

LED COMMERCIAL DOWNLIGHTS



PERFORMANCE SPECIFICATIONS



| Size | 4 Inch | 6 Inch | 8 Inch |
|------------------------------------|--|----------------|----------------|
| Power (Selectable) | 6W/8W/12W | 8W/11W/15W | 10W/20W/25W |
| Equivalent Power CFL | 26W | 32W | 36W |
| Input Voltage | 120-347Vac | | |
| Input Current | 0.100A (100mA) | 0.125A (125mA) | 0.208A (208mA) |
| Color Temperature | 2700K/3000K/3500K/4000K/5000K (SELECTABLE) | | |
| Lumens (Up to) | 1200lm at 12W | 1500lm at 15W | 2500lm at 25W |
| Efficacy | 100lm/W | | |
| Color Rendering Index (CRI) | +90 | | |
| Lifetime | 50,000 hours | | |
| Dimming Type | 1-10V dimming | | |
| Power Factor | 0.9 | | |
| Total Harmonic Distortion | <25% | | |

PHYSICAL SPECIFICATIONS

| Dimensions | 6" x 4.2" | 8.4" x 4.8" | 10" x 5.1" |
|------------------------------|--|--------------------|--------------------|
| Weight | 1.34 lbs (0.61 kg) | 1.76 lbs (0.80 kg) | 1.92 lbs (0.87 kg) |
| Beam Angle | 95° | | |
| Operating Temperature | -25°C to 40°C | | |
| Environment | Wet | | |
| Type of lens | Polycarbonate | | |
| Body material | Spinning aluminum reflector with a polycarbonate (PC) plastic driver box | | |

ORDERING INFORMATION:

 Stock item. Same Day Shipping for orders placed by 3pm EST

| SERIES | INPUT VOLTAGE | POWER (SELECTABLE) | LUMENS | COLOR TEMPERATURE (SELECTABLE) | MODEL NUMBER | ORDERING CODE |
|---------------------------|---------------|--------------------|-------------|--------------------------------|--------------------------|---|
| LED COMMERCIAL DOWNLIGHTS | 120 -347Vac | 6W/8W/12W | 1200LM@ 12W | 2700K/3000K/3500K /4000K/5000K | CDL04R0012W-DDKMVDWHS-V1 | CDL4-6W-12W-VAR-WH-V1  |
| | | 8W/11W/15W | 1500LM@ 15W | 2700K/3000K/3500K /4000K/5000K | CDL06R0015W-DDKMVDWHS-V1 | CDL6-8W-15W-VAR-WH-V1  |
| | | 10W/20W/25W | 2500LM@ 25W | 2700K/3000K/3500K /4000K/5000K | CDL08R0025W-DDKMVDWHS-V1 | CDL8-10W-25W-VAR-WH-V1  |

PRODUCT DIMENSIONS AND CUT-OUT

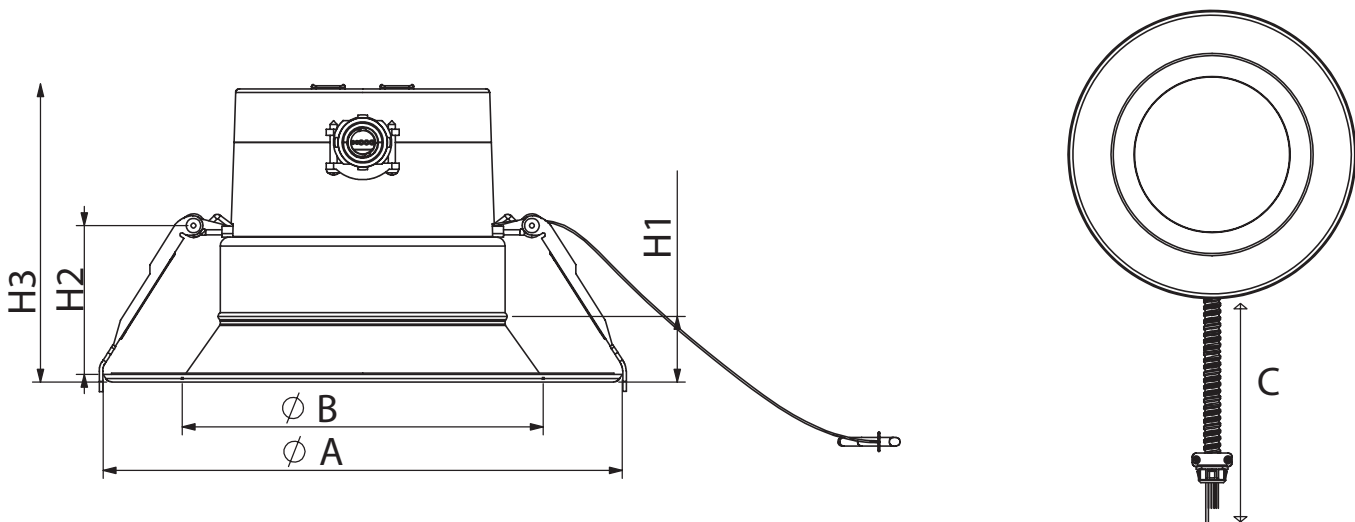

| Items | 4in | 6in | 8in |
|------------------------------------|---------------------|-------------------|--------------------|
| A (Overall Trim Diameter) | 6" (152 mm) | 8-7/16" (214 mm) | 10" (255 mm) |
| B (Aperture Diameter) | 4-1/2" (115 mm) | 5-15/16" (149 mm) | 7-1/8" (181 mm) |
| C (Flexible Conduit / Whip) | 26" (660 mm) | 26" (660 mm) | 26" (660 mm) |
| H1 (Ceiling Thickness) | 11/16" (18 mm) | 1" (26 mm) | 1-3/16" (30 mm) |
| H2 (Recess Height) | 1-13/16" (45 mm) | 2-3/16" (56 mm) | 2-1/2" (64 mm) |
| H3 (Assembled) | 4-3/16" (107 mm) | 4-13/16" (123 mm) | 5-1/16" (129 mm) |
| Min. Cut-out | Ø 4-15/16" (120 mm) | Ø 6-1/8" (155 mm) | Ø 7-9/16" (186 mm) |

PHOTOMETRIC REPORTS

CDL4-6W-12W-VAR-WH-V1 (4000K)

Polar Candela Distribution

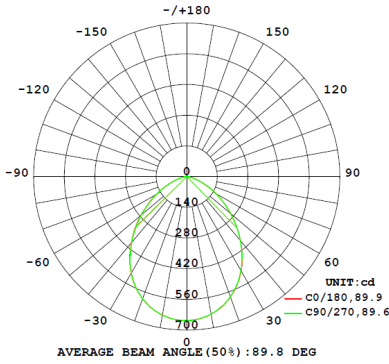

Illuminance at distance

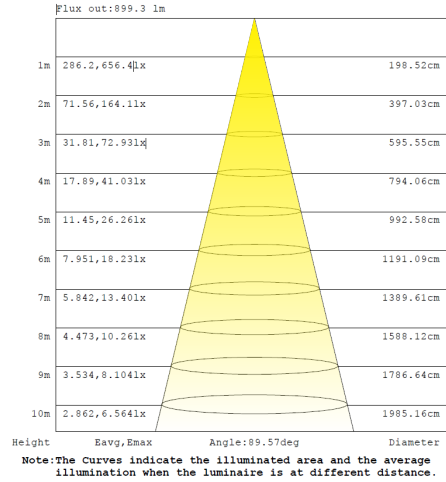

Zonal Lumen Summary

| Zone | Lumens | Luminaire % |
|-------|--------|-------------|
| 0-30 | 460.5 | 35.6% |
| 0-40 | 724.9 | 56% |
| 0-60 | 1143.5 | 88.4% |
| 60-90 | 150.0 | 11.6% |
| 0-90 | 1293.5 | 100% |

| 4-Inch LED Commercial Downlight: Lumen Output | | | | | |
|---|--------|--------|--------|--------|--------|
| Power | 27K | 30K | 35K | 40K | 50K |
| 6W | 570lm | 600lm | 612lm | 630lm | 630lm |
| 8W | 807lm | 850lm | 867lm | 892lm | 892lm |
| 12W | 1140lm | 1200lm | 1224lm | 1260lm | 1260lm |

CDL6-8W-15W-VAR-WH-V1 (4000K)

Polar Candela Distribution

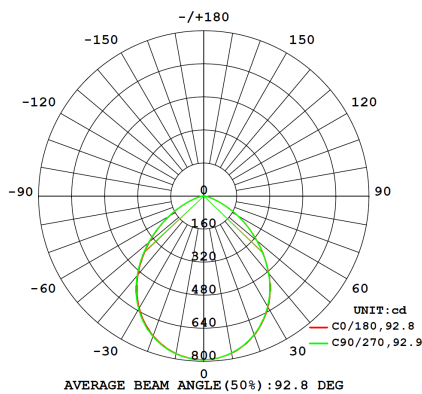

Illuminance at distance

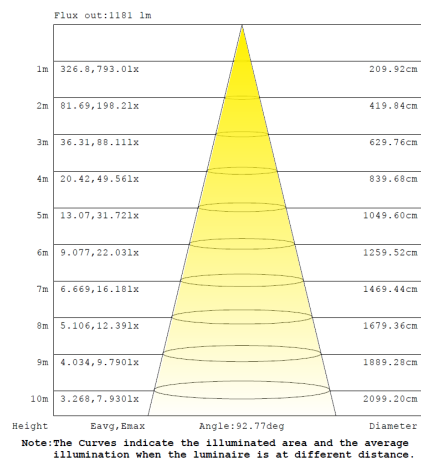

Zonal Lumen Summary

| Zone | Lumens | Luminaire % |
|-------|--------|-------------|
| 0-30 | 553.4 | 35.6% |
| 0-40 | 878.3 | 56.5% |
| 0-60 | 1392.4 | 89.6% |
| 60-90 | 161.4 | 10.4% |
| 0-90 | 1553.7 | 100% |

| 6-Inch LED Commercial Downlights: Lumen Output | | | | | |
|--|--------|--------|--------|--------|--------|
| Power | 27K | 30K | 35K | 40K | 50K |
| 8W | 712lm | 750lm | 765lm | 788lm | 788lm |
| 11W | 1045lm | 1100lm | 1122lm | 1155lm | 1155lm |
| 15W | 1425lm | 1500lm | 1530lm | 1575lm | 1575lm |

CDL8-10W-25W-VAR-WH-V1 (4000K)

Polar Candela Distribution

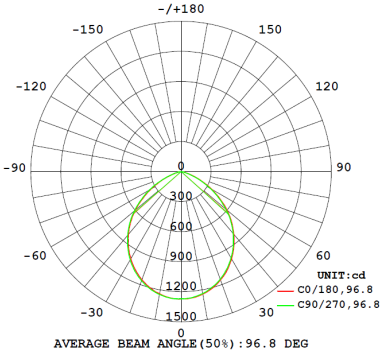

Illuminance at distance

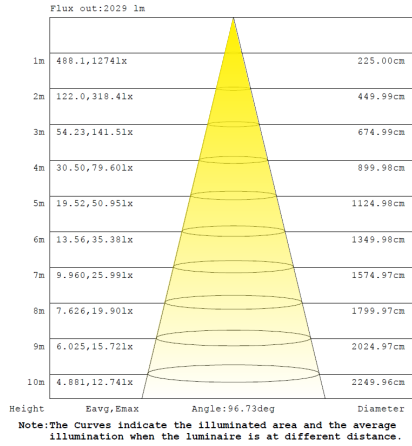

Zonal Lumen Summary

| Zone | Lumens | Luminaire % |
|-------|--------|-------------|
| 0-30 | 900.1 | 34.1% |
| 0-40 | 1440.2 | 54.5% |
| 0-60 | 2351.4 | 89% |
| 60-90 | 289.8 | 11% |
| 0-90 | 2641.2 | 100% |

| 8-Inch LED Commercial Downlights: Lumen Output | | | | | |
|--|--------|--------|--------|--------|--------|
| Power | 27K | 30K | 35K | 40K | 50K |
| 10W | 950lm | 1000lm | 1020lm | 1050lm | 1050lm |
| 20W | 1950lm | 2000lm | 2040lm | 2100lm | 2100lm |
| 25W | 2375lm | 2500lm | 2550lm | 2625lm | 2625lm |